

NON-ISOLATED DC/DC CONVERTERS

2.4 Vdc - 5.5 Vdc Input

0.75 Vdc - 3.63 Vdc/6 A Output

bel
POWER PRODUCTS

SRBA-06F1Ax

RoHS Compliant

Rev.A

- Non-Isolated
- High Efficiency
- High Power Density
- Fixed Frequency (300 kHz)
- Converter Can Sink and Source Current
- Under-voltage Lockout (UVLO)
- Wide Trim
- OCP/SCP
- Remote On/Off
- Active Low/High (Option)



Description

The Bel SRBA-06F1Ax modules are a series of non-isolated dc/dc converters that deliver up to 6 A of output current with full load efficiency of 93% at 3.3 Vdc output. These modules provide precisely regulated voltage programmable via external resistor from 0.75 Vdc to 3.63 Vdc over a wide range of input voltage (2.4 Vdc - 5.5 Vdc). The open-frame construction and small footprint enable designers to develop cost and space-efficient solutions. Standard features include remote On/Off, over current protection, short circuit protection, wide input, and programmable output voltage.

Part Selection

Output Voltage	Input Voltage	Max. Output Current	Max. Output Power	Typical Efficiency	Model Number Active Low	Model Number Active High
0.75 V - 3.63 V ¹	2.4 V - 5.5 V	6 A	21.8 W	93%	SRBA-06F1AL	SRBA-06F1A0

- Notes:**
1. These modules use a buck topology, so the output voltages must be 0.5 V less than the input voltage.
 2. Add "G" to the end of the Model Number to indicate Tray Packaging.
 3. All part numbers above indicate RoHS 6. Change the second letter "R" to "7" for RoHS 5 part numbers.

Absolute Maximum Ratings

Parameter	Min	Typ	Max	Notes
Input Voltage (continuous)	-0.3 V	-	5.8 V	
Output Enable Terminal Voltage	-0.3 V	-	5.5 V	
Ambient Temperature	-40 °C	-	85 °C	
Storage Temperature	-55 °C	-	125 °C	

Note: All specifications are typical at 25 °C unless otherwise stated.

NON-ISOLATED DC/DC CONVERTERS

2.4 Vdc - 5.5 Vdc Input

0.75 Vdc - 3.63 Vdc/6 A Output



Input Specifications

Parameter	Min	Typ	Max	Notes
Input Voltage	2.4 V	-	5.5 V	$V_o, set \leq V_{in} - 0.5 V$
Input Current (full load)				
$V_o = 3.3V$	-	-	4.73 A	
$V_o = 2.5V$	-	-	3.66 A	
$V_o = 1.8V$	-	-	4.09 A	
$V_o = 1.5V$	-	-	4.31 A	
$V_o = 1.2V$	-	-	3.57 A	
$V_o = 0.75V$	-	-	2.40 A	
Input Current (no load)				
$V_o = 3.3 V$	-	50 mA	-	
$V_o = 0.75 V$	-	25 mA	-	
Remote Off Input Current	-	0.6 mA	-	
Input Reflected Ripple Current (pk-pk)	-	120 mA	-	Tested with simulated source impedance of 1 μH , 5 Hz to 20 MHz, one 1000 μF /25 V AL capacitor and two 100 μF / 10 V Tantalum capacitor at the input.
Input Reflected Ripple Current (rms)	-	35 mA	-	
I^2t Inrush Current Transient	-	-	0.04 A^2s	
Turn-on Voltage Threshold	-	2.05 V	2.4 V	
Turn-off Voltage Threshold	1.8 V	2.0 V	-	

Note: All specifications are typical at nominal input, full load at 25 °C unless otherwise stated.

Output Specifications

Parameter	Min	Typ	Max	Notes	
Output Voltage Set Point	-2% V_o, set	-	2% V_o, set	$V_{in} = 5 V, I_o = 50\% I_o, max$	
Output Voltage Set Point	-3% V_o, set	-	3% V_o, set	Over all operating input voltages, resistive loads and temperature conditions	
Adjustment Range Selected by External Resistor or Voltage	0.7525 V	-	3.63 V		
Load Regulation	-	0.4% V_o, set	-	$I_o = I_{o, min}$ to 50% $I_{o, max}$	
Line Regulation	-	0.3% V_o, set	-	$V_{in} = 50\% V_{in, min}$ to $V_{in, max}$	
Regulation Over Temperature (-40 °C to +85 °C)	-	0.4% V_o, set	-	$T_{ref} = T_{min}$ to T_{max}	
Output Current	0 A	-	6 A		
Current Limit Threshold	9 A	-	18 A		
Short Circuit Surge Transient	-	0.32 A^2s	-		
Ripple and Noise (pk-pk)	-	40 mV	70 mV	Tested with 0-20 MHz, with 10 μF Tantalum capacitor & 1 μF /10 V ceramic capacitor at the output.	
Ripple and Noise (rms)	-	10 mV	30 mV		
Turn on Time	-	6 mS	10 mS		
Overshoot at Turn on	-	-	3%		
Output Capacitance					
$ESR \geq 1mohm$	0 μF	-	1000 μF		
$ESR \geq 10mohm$	0 μF	-	3000 μF		
Transient Response					
50% ~ 100% Max Load	$V_o = 0.75 V - 3.63 V$	-	130 mV	-	$di/dt = 2.5 A/\mu S$; $V_{in} = 5 V$; and with 10 μF Tantalum capacitor & 1 μF /10 V TDK ceramic capacitor at the output
Settling Time		-	25 μS	-	
100% ~ 50% Max Load		-	130 mV	-	
Settling Time		-	25 μS	-	

Note: All specifications are typical at nominal input, full load at 25 °C unless otherwise stated.

NON-ISOLATED DC/DC CONVERTERS

2.4 Vdc - 5.5 Vdc Input

0.75 Vdc - 3.63 Vdc/6 A Output



General Specifications

Parameter	Min	Typ	Max	Notes
Efficiency				
Vo=3.3 V	-	93%	-	Measured at Vin=5 V, full load
Vo=2.5 V	-	91%	-	
Vo=1.8 V	-	88%	-	
Vo=1.5 V	-	87%	-	
Vo=1.2 V	-	84%	-	
Vo=0.75 V	-	78%	-	
Switching Frequency	250 kHz	300 kHz	350 kHz	
Over Temperature Shutdown	-	135 °C	-	
Output Voltage Trim Range	0.7525 V	-	3.63 V	
MTBF	6,954,974 hours			Calculated Per Bell Core SR-332 (Vin=5 V; Vo=0.75 V; Io = 4.8 A; Ta = 25°C)
Dimensions				
Inches (L × W × H)	1.0 x 0.5 x 0.243			
Millimeters (L × W × H)	25.4 x 12.7 x 6.16			
Weight	-	5 g	-	

Note: All specifications are typical at 25 °C unless otherwise stated.

Control Specifications

Parameter	Min	Typ	Max	Notes
Remote On/Off				
Signal Low (Unit Off)	-0.2 V	-	0.3 V	SRBA-06F1A0; Remote On/Off pin open, Unit on.
Signal High (Unit On)	-	-	Vin, max	
Signal Low (Unit On)	-0.2 V	-	0.3 V	SRBA-06F1AL; Remote On/Off pin open, Unit on.
Signal High (Unit Off)	1.5 V	-	Vin, max	

NON-ISOLATED DC/DC CONVERTERS

2.4 Vdc - 5.5 Vdc Input

0.75 Vdc - 3.63 Vdc/6 A Output

bel
POWER PRODUCTS

Remote Enable Specifications

The SRBA-06F1AL modules feature an enable pin with negative logic. If not using the enable pin, leave the pin open (the module will be on). During logic_high, the module is turned off, during logic_low, the module is turned on. Its inner circuit impedance is shown as figure.

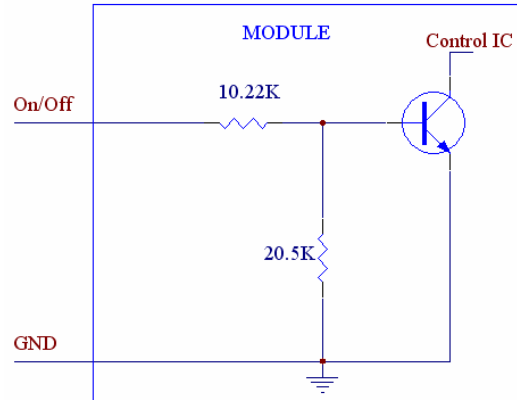

SRBA-06F1AL

The SRBA-06F1A0 modules feature an enable pin with Positive logic. If not using the enable pin, leave the pin open (the module will be on). During logic_high, the module is turned on, during logic_low, the module is turned off. Its inner circuit impedance is shown as figure.

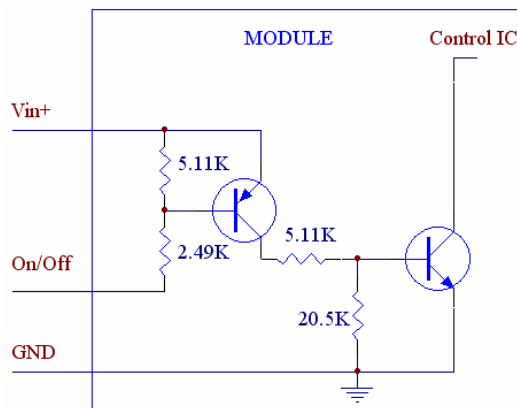

SRBA-06F1A0

Output Trim Equations

Equation for calculating the trim resistor (in kΩ) given the desired adjusted voltage (V_{adj}) is shown below. The Trim Up resistor should be connected between the Trim pin and Ground.

$$R_{trim} = \frac{21.07}{V_{adj} - 0.7525} - 5.11$$

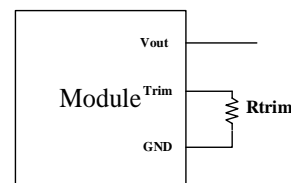

Equation for calculating the trim voltage (in V) given the desired adjusted voltage (V_{adj}) is shown below. The Trim Up voltage should be connected between the Trim pin and Ground.

$$V_{trim} = 0.7 - 0.1698 \times (V_{adj} - 0.7525)$$

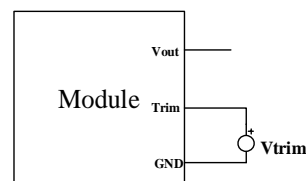

NON-ISOLATED DC/DC CONVERTERS

2.4 Vdc - 5.5 Vdc Input

0.75 Vdc - 3.63 Vdc/6 A Output



Efficiency Data

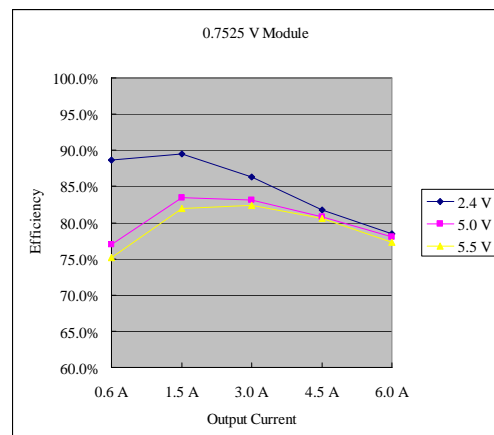
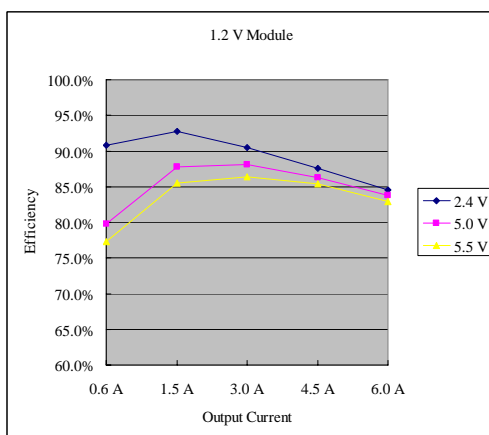
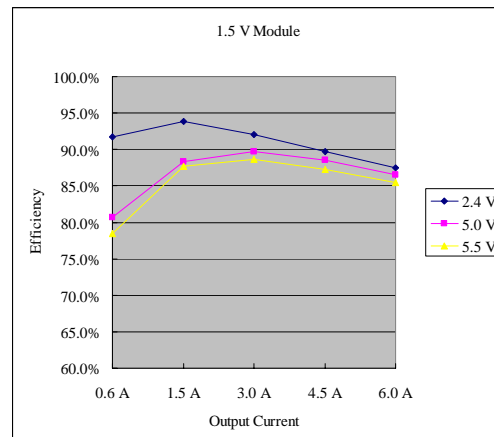
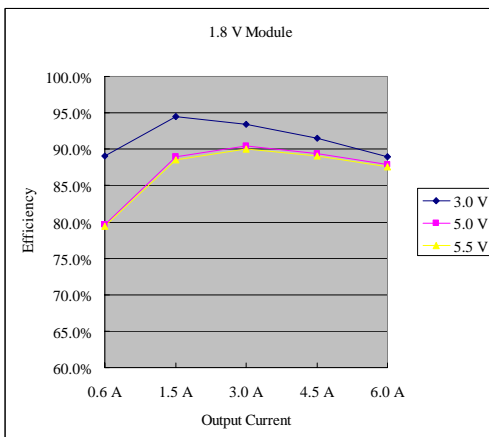
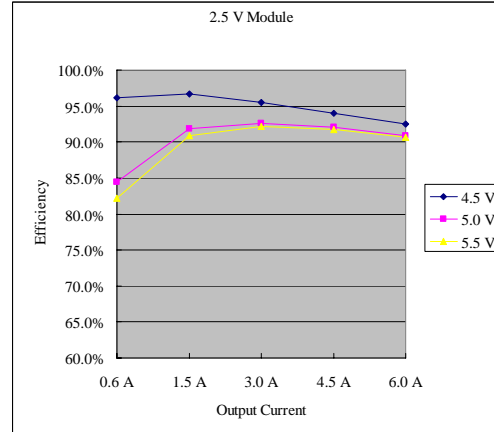
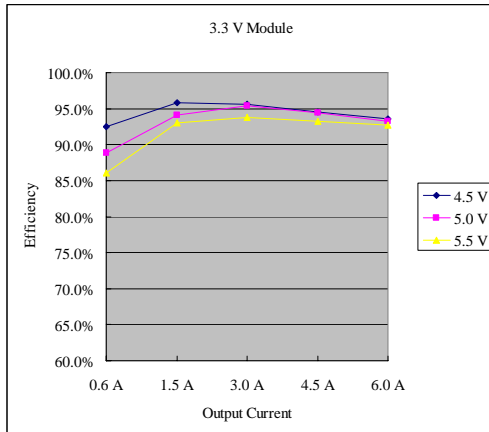

NON-ISOLATED DC/DC CONVERTERS

2.4 Vdc - 5.5 Vdc Input

0.75 Vdc - 3.63 Vdc/6 A Output



Thermal Derating Curves

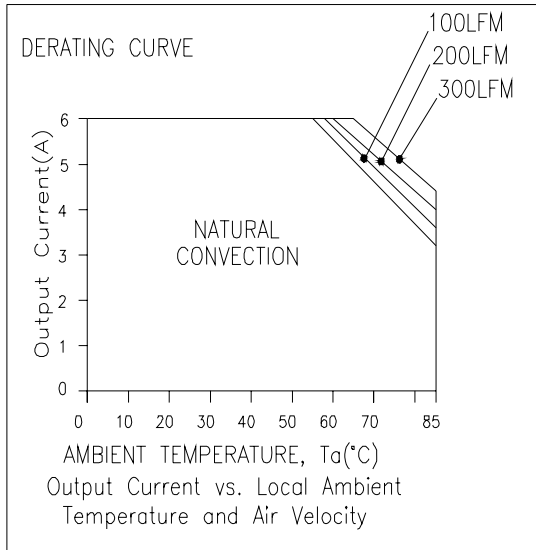

Vin=5 V, Vo = 3.3 V

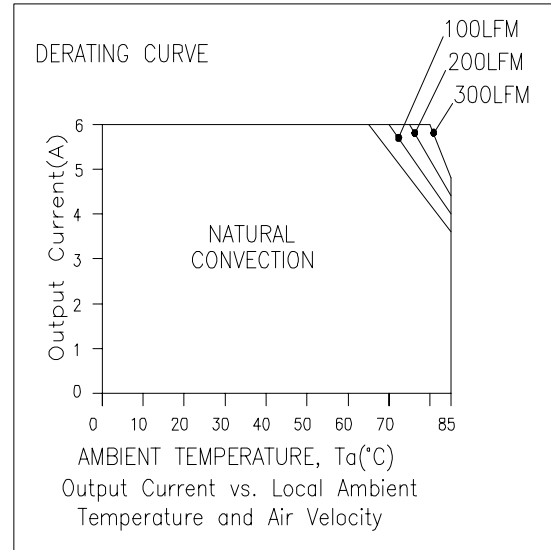

Vin=5 V, Vo = 0.75 V

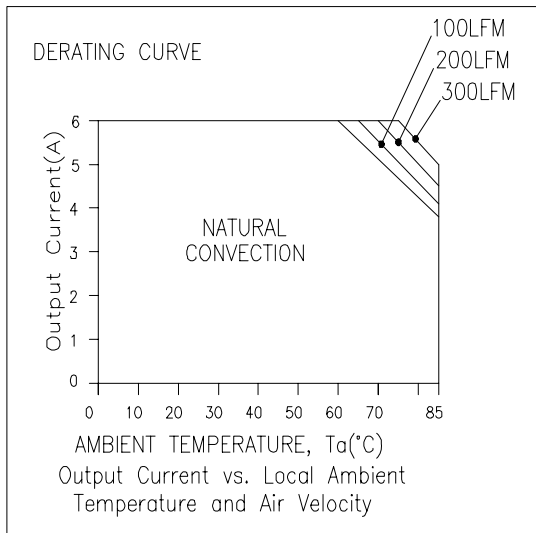

Vin=4.5 V, Vo = 2.5 V

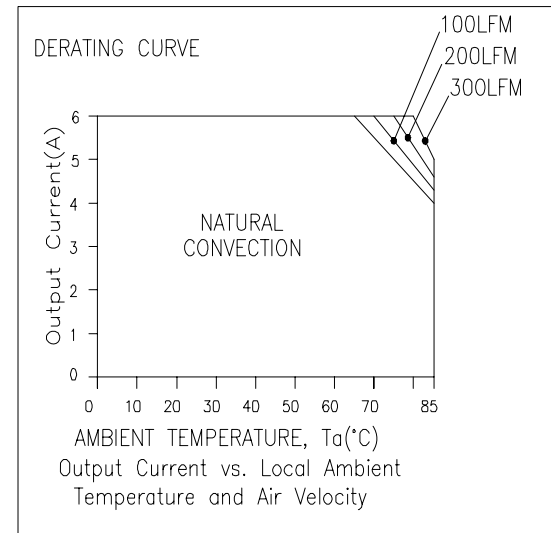

Vin=3.3 V, Vo = 0.75 V

NON-ISOLATED DC/DC CONVERTERS

2.4 Vdc - 5.5 Vdc Input

0.75 Vdc - 3.63 Vdc/6 A Output



Ripple and Noise Waveforms

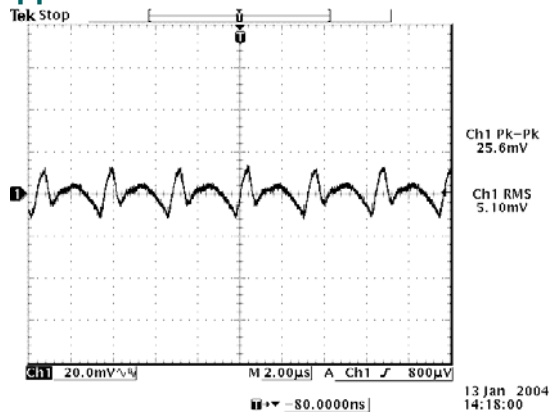

Ripple and noise at full load, $V_{in}=5.0\text{ V}$, $V_o=0.7525\text{ V}$

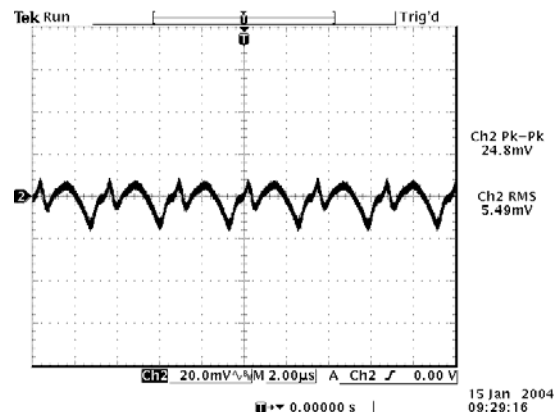

Ripple and noise at full load, $V_{in}=5.0\text{ V}$, $V_o=1.2\text{ V}$

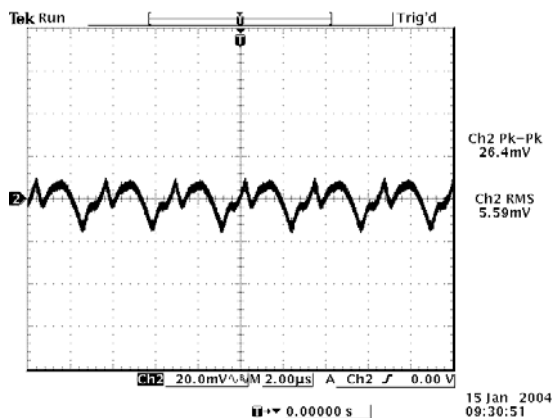

Ripple and noise at full load, $V_{in}=5.0\text{ V}$, $V_o=1.5\text{ V}$

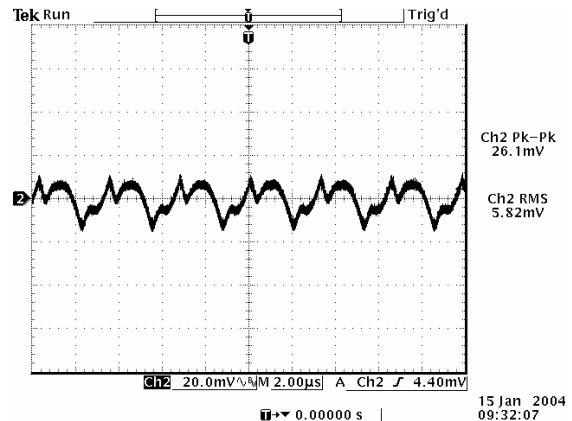

Ripple and noise at full load, $V_{in}=5.0\text{ V}$, $V_o=1.8\text{ V}$

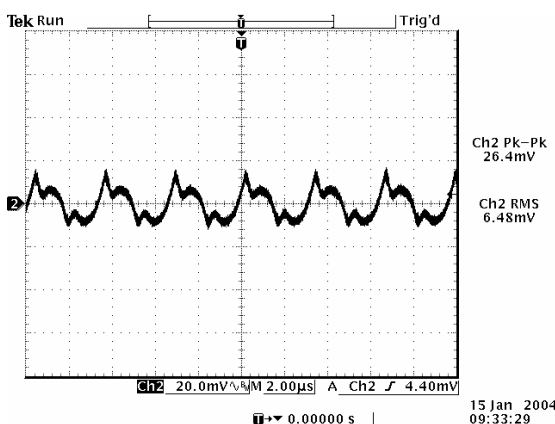

Ripple and noise at full load, $V_{in}=5.0\text{ V}$, $V_o=2.5\text{ V}$

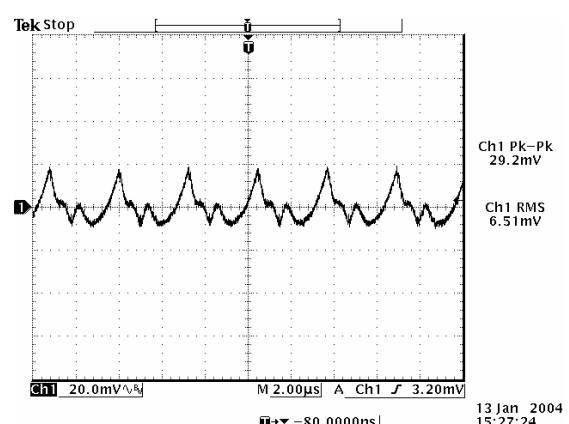

Ripple and noise at full load, $V_{in}=5.0\text{ V}$, $V_o=3.3\text{ V}$

Note: Ripple and noise is tested at 0-20 MHz BW, 10 μF /10 V tantalum capacitor and 1 μF /10 V ceramic capacitor, $T_a=25\text{ deg C}$.

NON-ISOLATED DC/DC CONVERTERS

2.4 Vdc - 5.5 Vdc Input

0.75 Vdc - 3.63 Vdc/6 A Output



Transient Response Waveforms

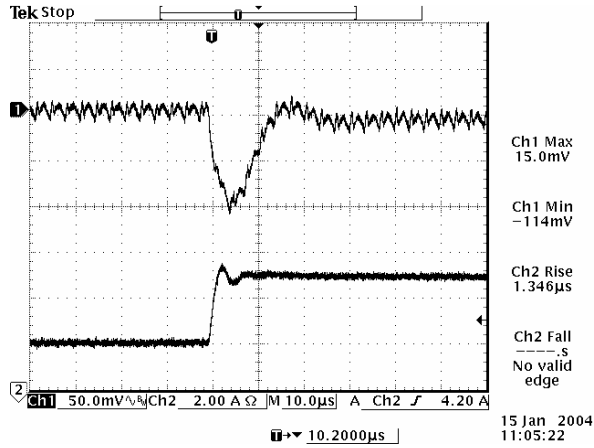

50% to 100% load step at $V_{in}=5\text{ V}$, $V_o=0.75\text{ V}$

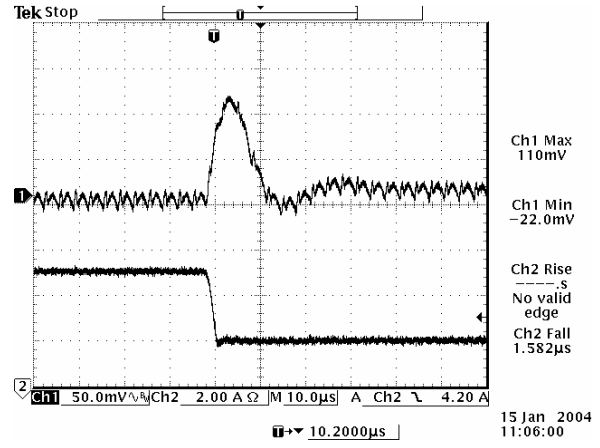

100% to 50% load step at $V_{in}=5\text{ V}$, $V_o=0.75\text{ V}$

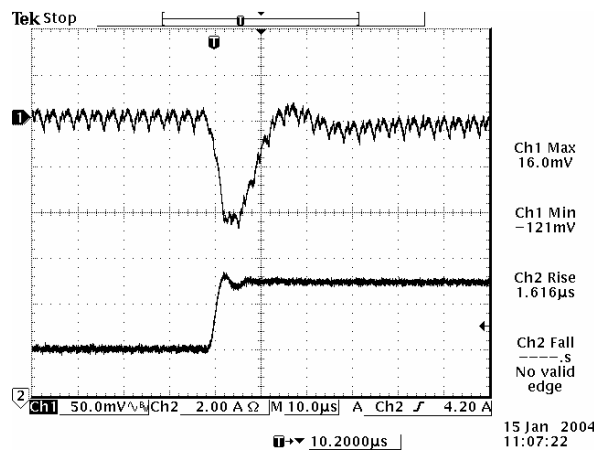

50% to 100% load step at $V_{in}=5\text{ V}$, $V_o=1.2\text{ V}$

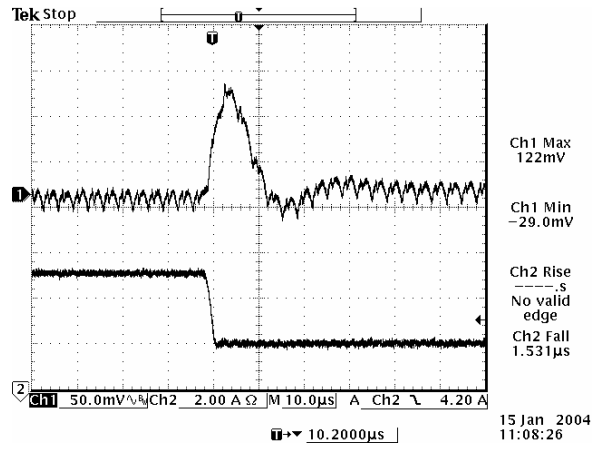

100% to 50% load step at $V_{in}=5\text{ V}$, $V_o=1.2\text{ V}$

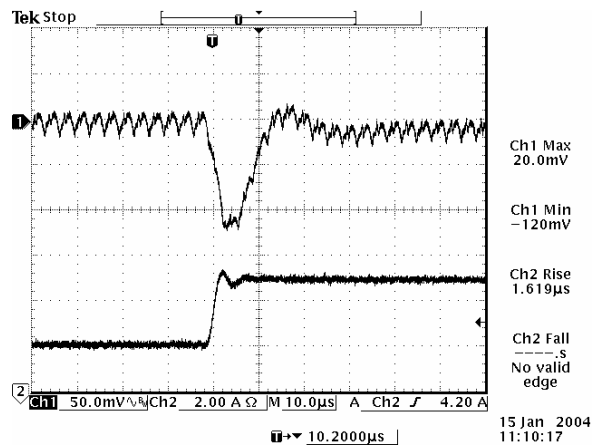

50% to 100% load step at $V_{in}=5\text{ V}$, $V_o=1.5\text{ V}$

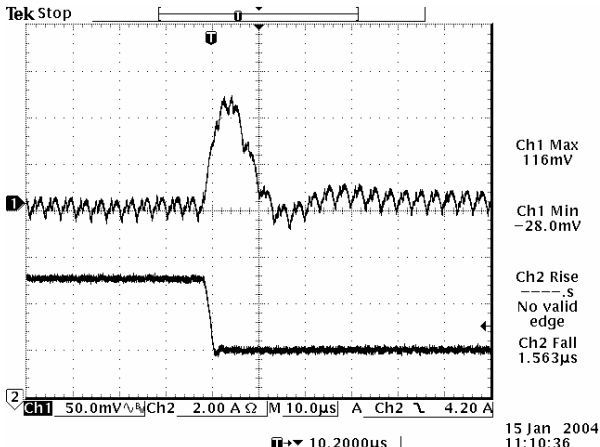

100% to 50% load step at $V_{in}=5\text{ V}$, $V_o=1.5\text{ V}$

NON-ISOLATED DC/DC CONVERTERS

2.4 Vdc - 5.5 Vdc Input

0.75 Vdc - 3.63 Vdc/6 A Output



Transient Response Waveforms (continued)

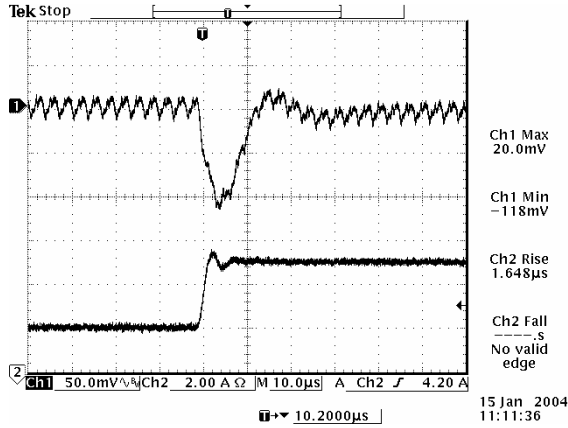

50% to 100% load step at $V_{in}=5\text{ V}$, $V_o=1.8\text{ V}$

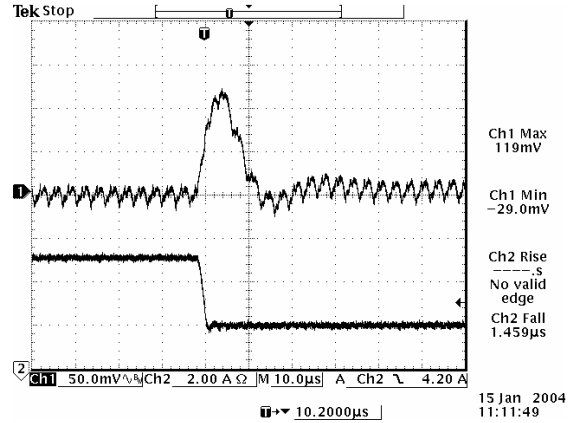

100% to 50% load step at $V_{in}=5\text{ V}$, $V_o=1.8\text{ V}$

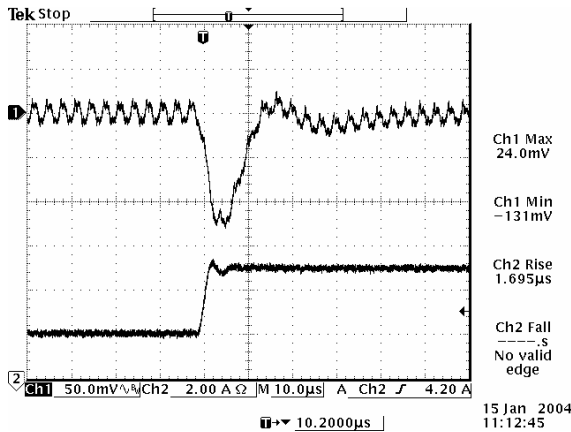

50% to 100% load step at $V_{in}=5\text{ V}$, $V_o=2.5\text{ V}$

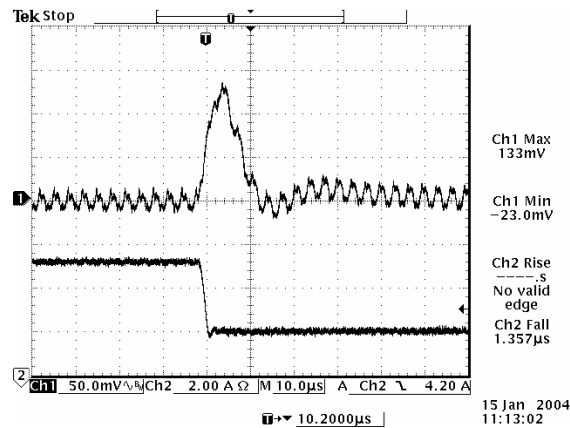

100% to 50% load step at $V_{in}=5\text{ V}$, $V_o=2.5\text{ V}$

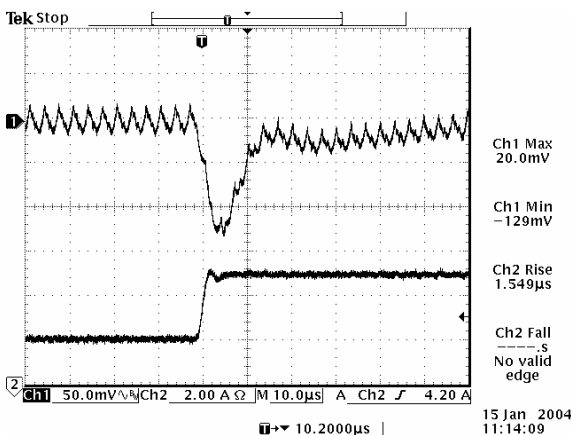

50% to 100% load step at $V_{in}=5\text{ V}$, $V_o=3.3\text{ V}$

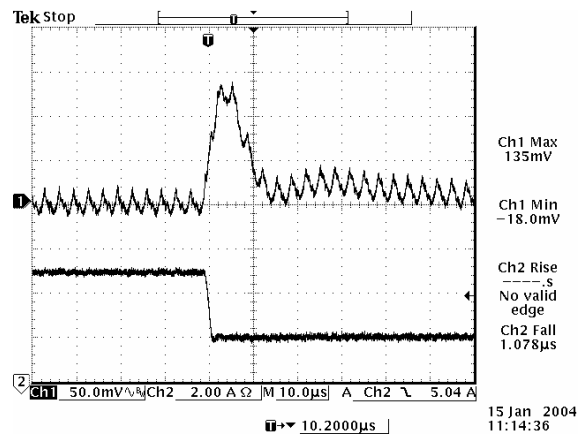

100% to 50% load step at $V_{in}=5\text{ V}$, $V_o=3.3\text{ V}$

Note: Transient response is tested at $di/dt=2.5\text{ A}/\mu\text{S}$, with $10\text{ }\mu\text{F}/10\text{ V}$ tantalum capacitor and $1\text{ }\mu\text{F}/10\text{ V}$ ceramic capacitor, $T_a=25\text{ deg C}$.

NON-ISOLATED DC/DC CONVERTERS

2.4 Vdc - 5.5 Vdc Input

0.75 Vdc - 3.63 Vdc/6 A Output



Mechanical Outline

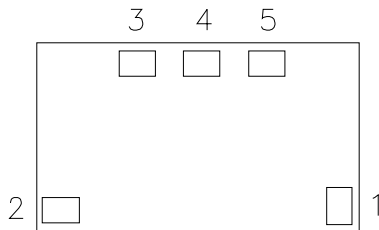
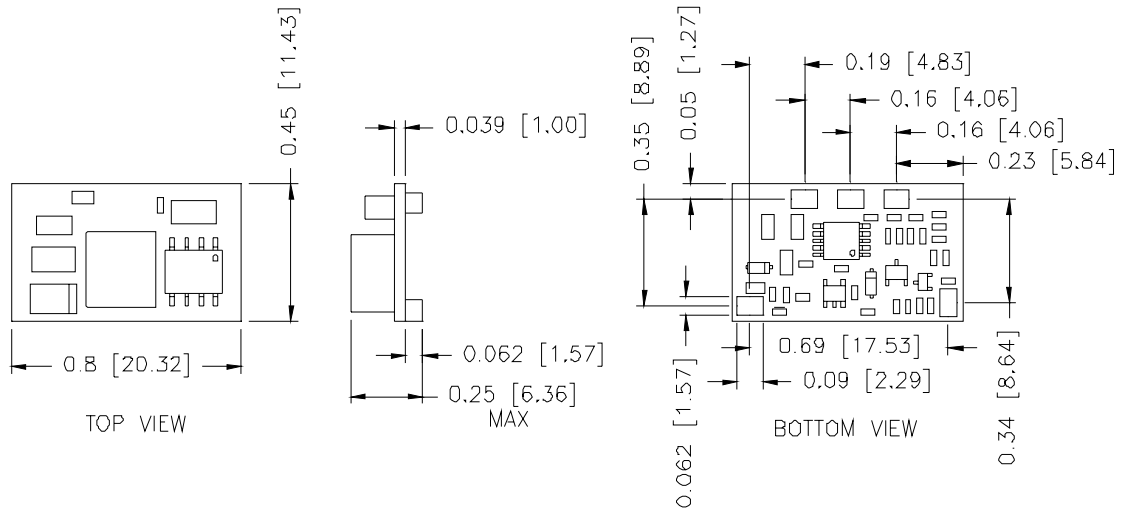

Pin Connections

Pin	Function
1	Remote On/Off
2	Vin
3	Ground
4	Trim
5	Vout

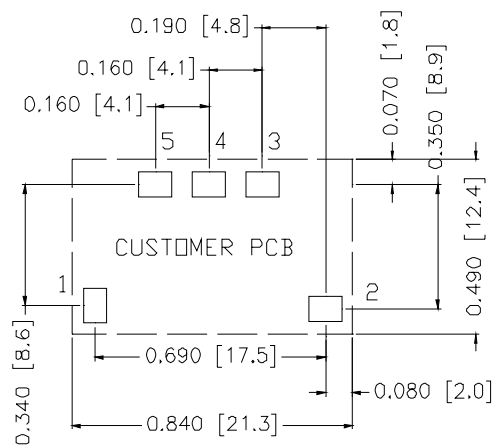

PAD SIZE:
MIN: 0.12" * 0.095" (3.05mm * 2.41mm)
MAX: 0.135" * 0.11" (3.43mm * 2.79mm)

RoHS Compliance

Complies with the European Directive 2002/95/EC, calling for the elimination of lead and other hazardous substances from electronic products.



©2007 Bel Fuse Inc. Specifications subject to change without notice. 011207

CORPORATE

Bel Fuse Inc.
206 Van Vorst Street
Jersey City, NJ 07302
Tel 201-432-0463
Fax 201-432-9542
www.belfuse.com

FAR EAST

Bel Fuse Ltd.
8F/ 8 Luk Hop Street
San Po Kong
Kowloon, Hong Kong
Tel 852-2328-5515
Fax 852-2352-3706
www.belfuse.com

EUROPE

Bel Fuse Europe Ltd.
Preston Technology Management Centre
Marsh Lane, Suite G7, Preston
Lancashire, PR1 8UD, U.K.
Tel 44-1772-556601
Fax 44-1772-888366
www.belfuse.com